

Teil 1: Struktur der Materie

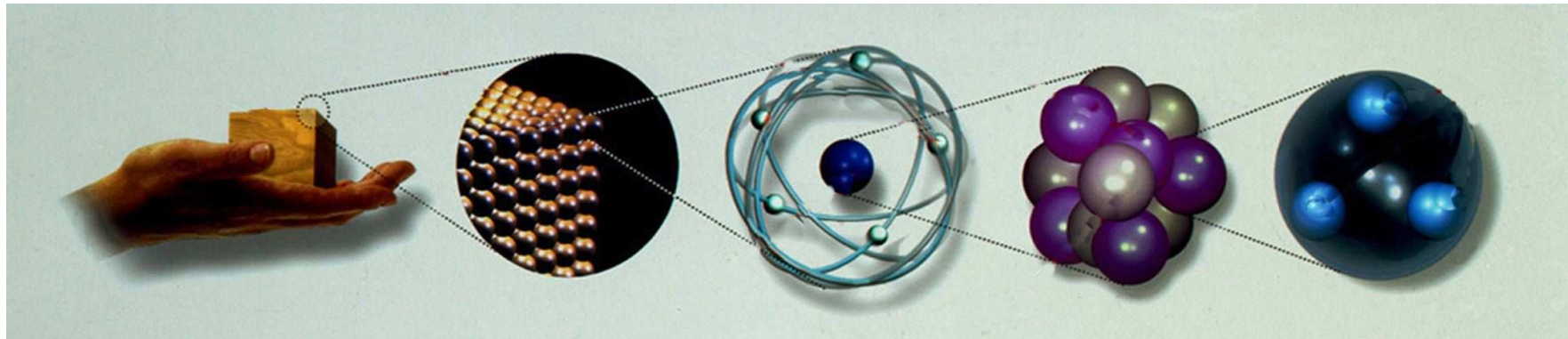

Materie

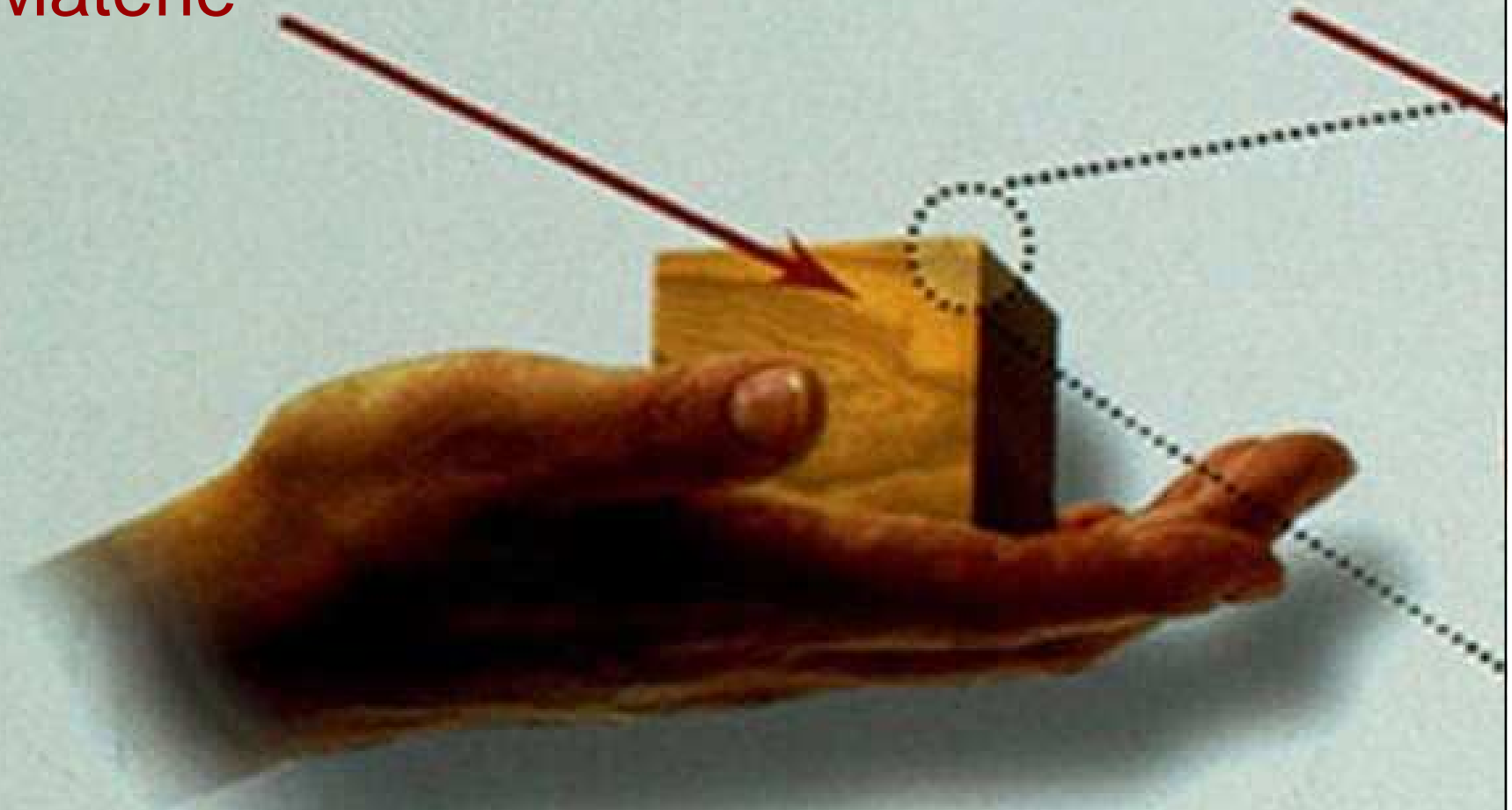

Atom

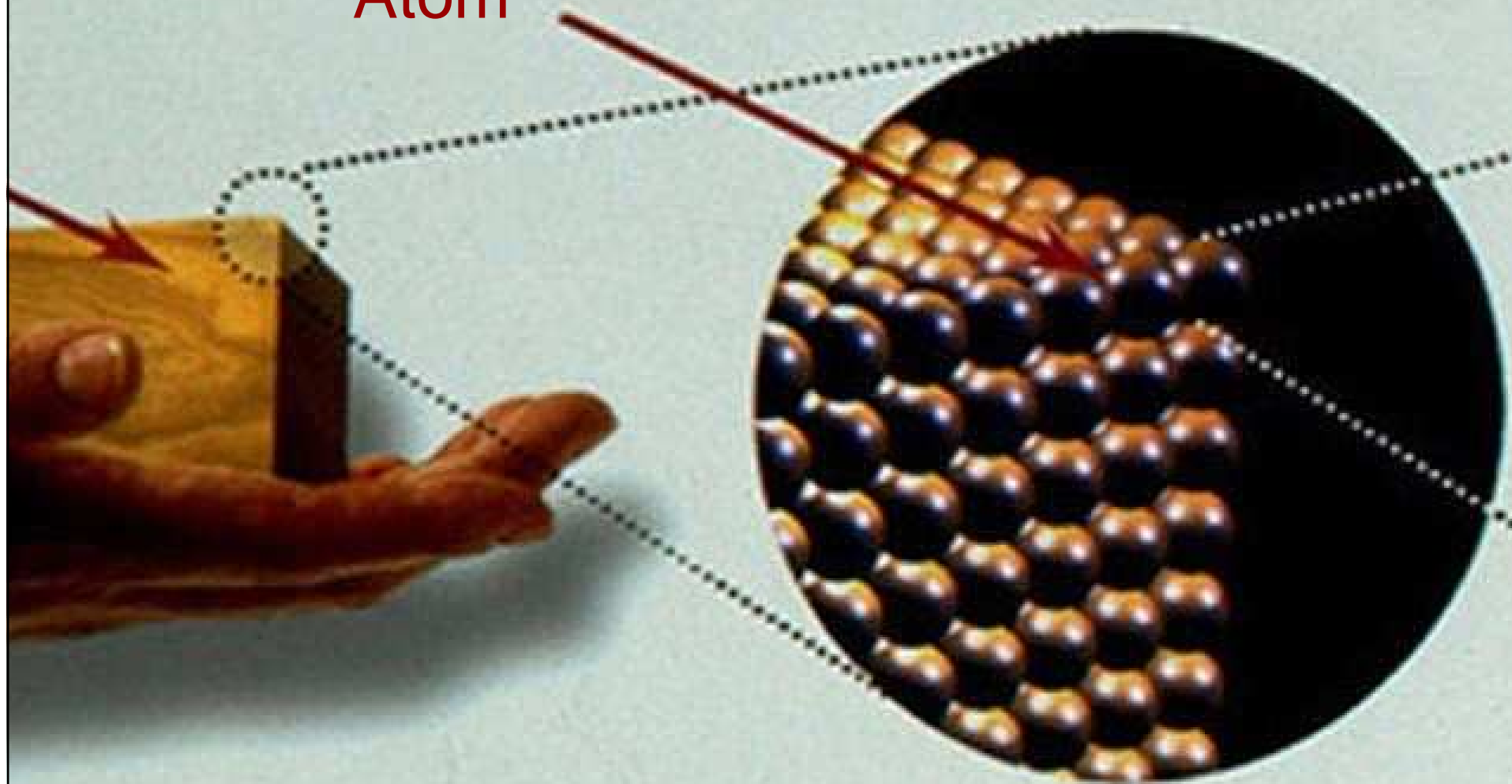

Elektron

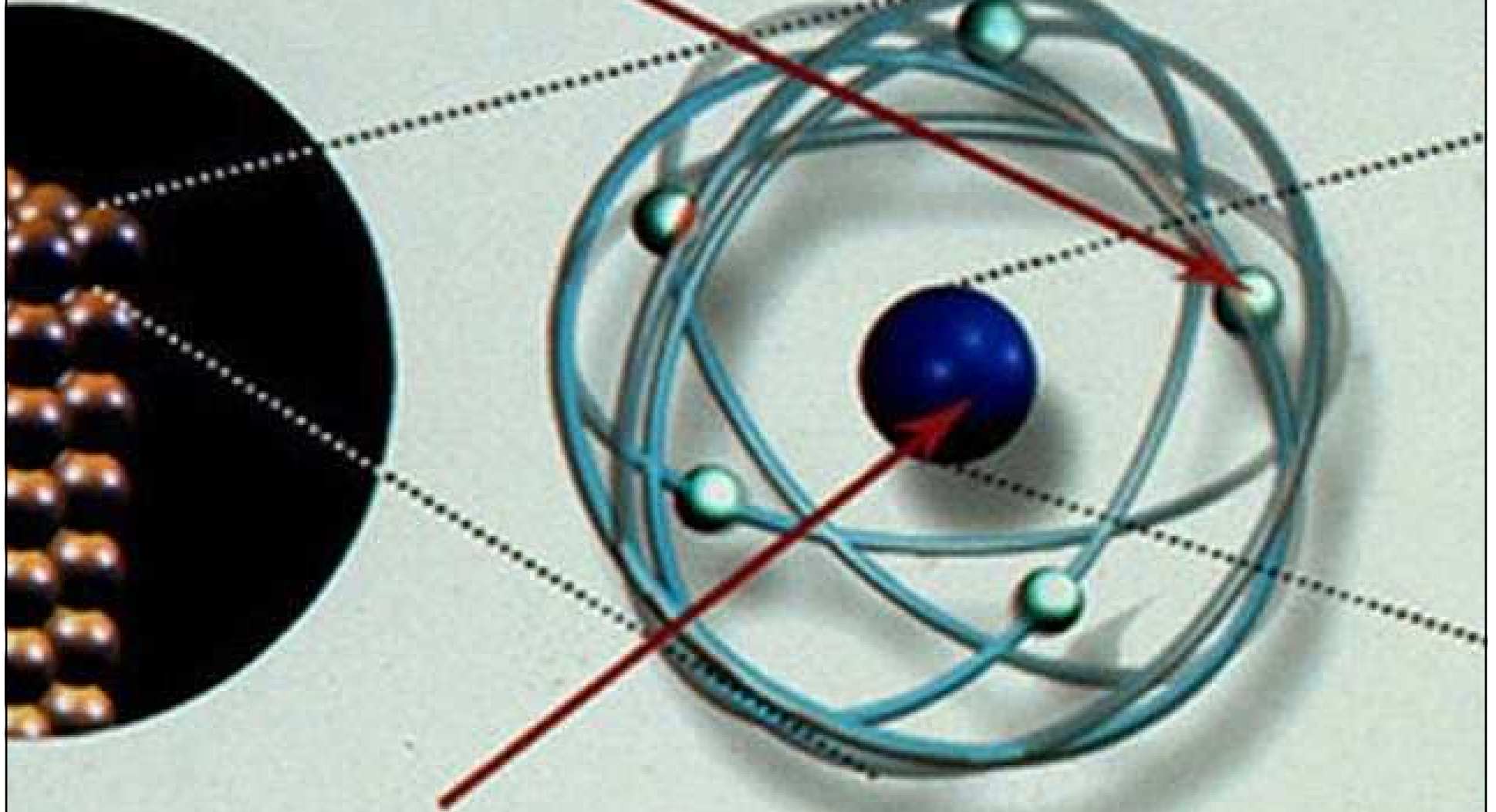

Atomkern

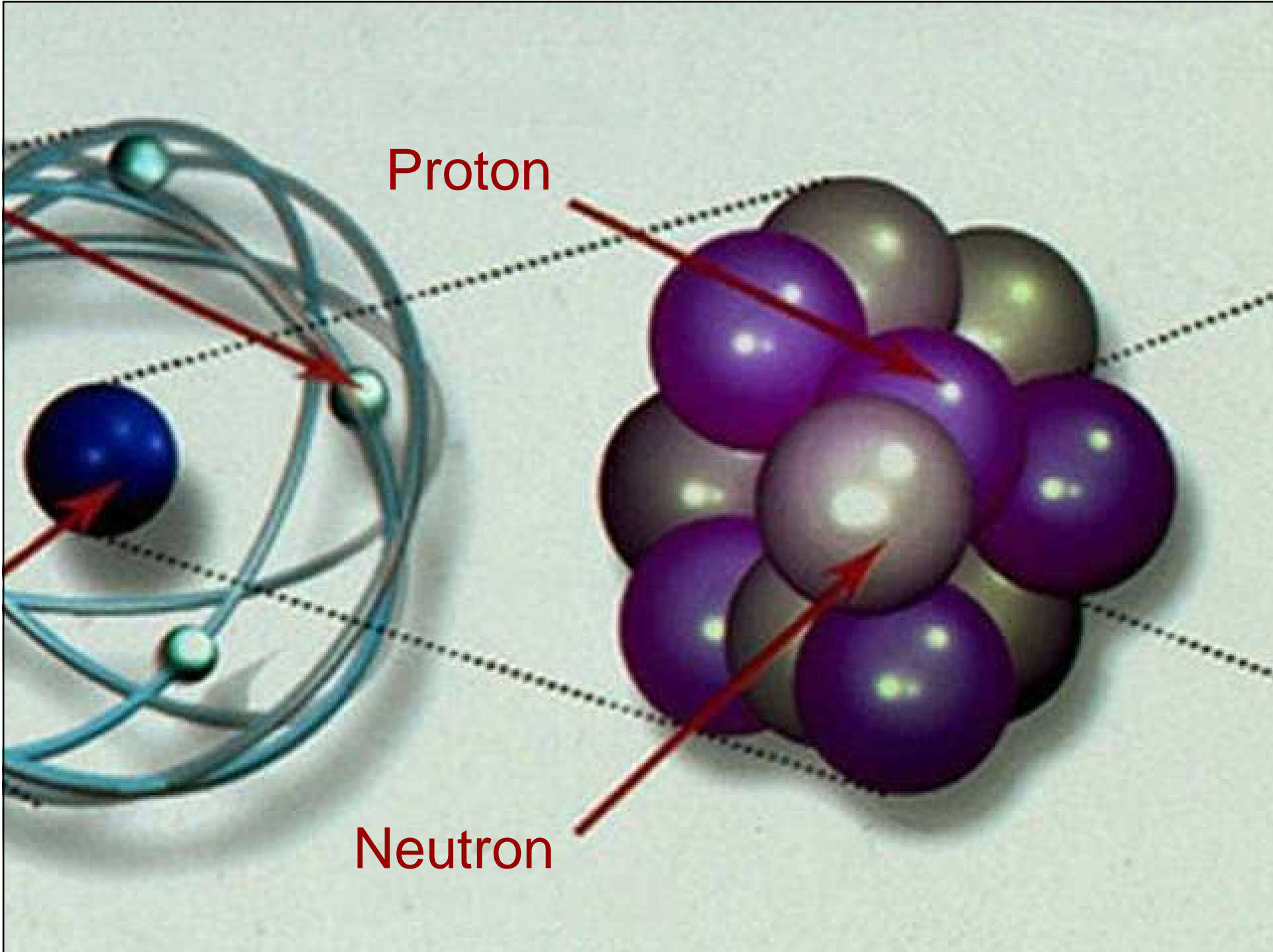

Quarks

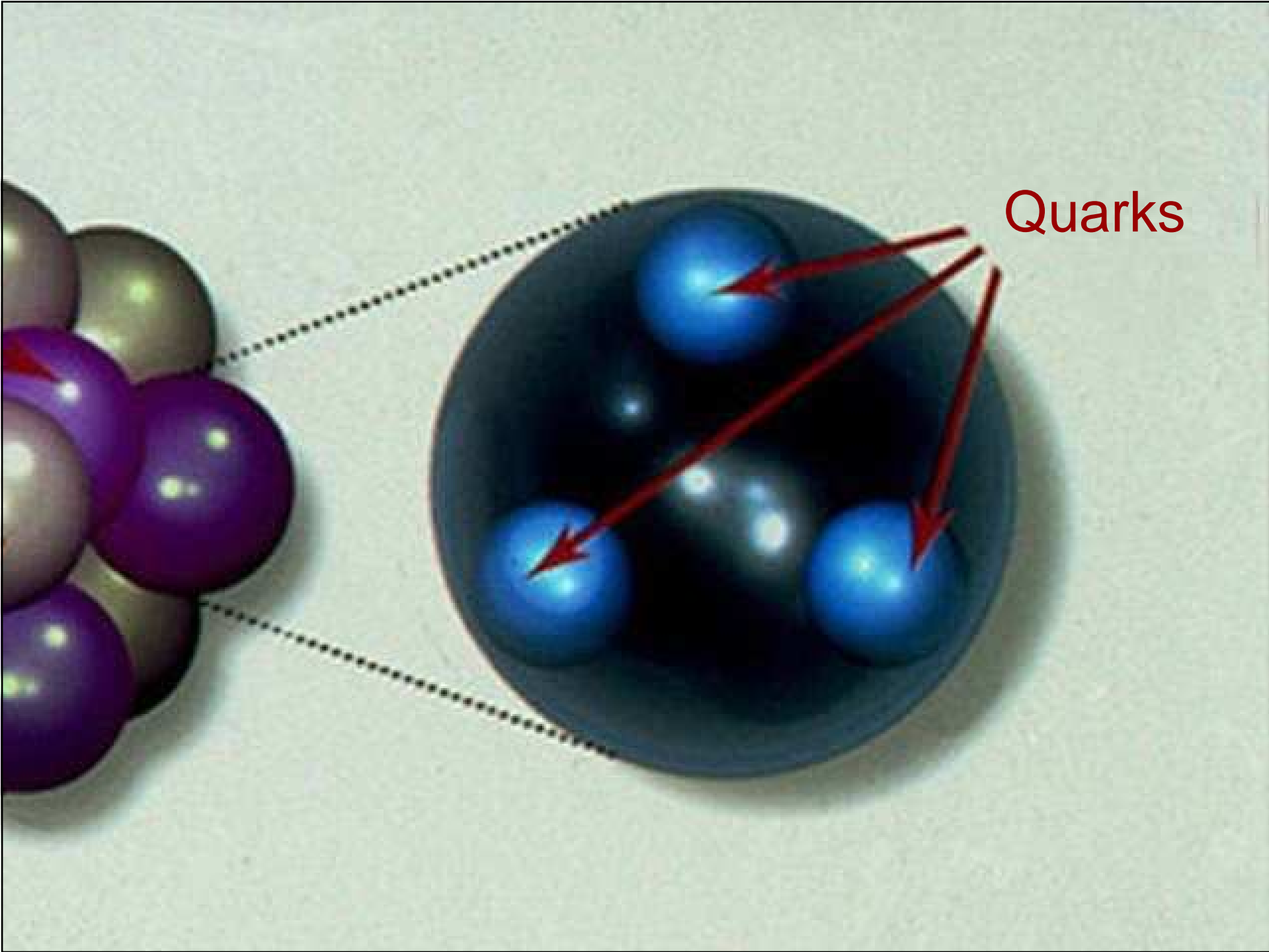

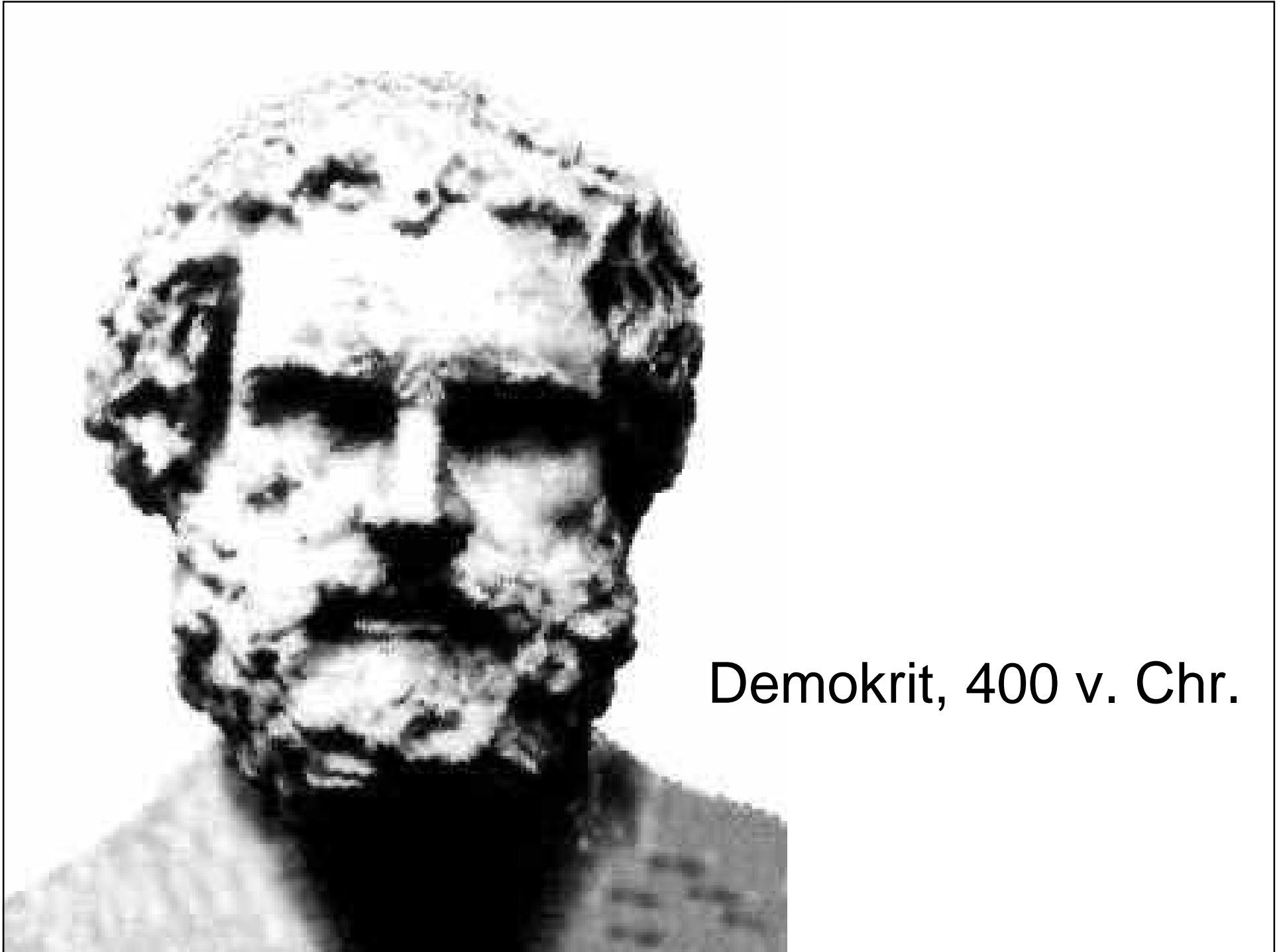

Demokrit, 400 v. Chr.

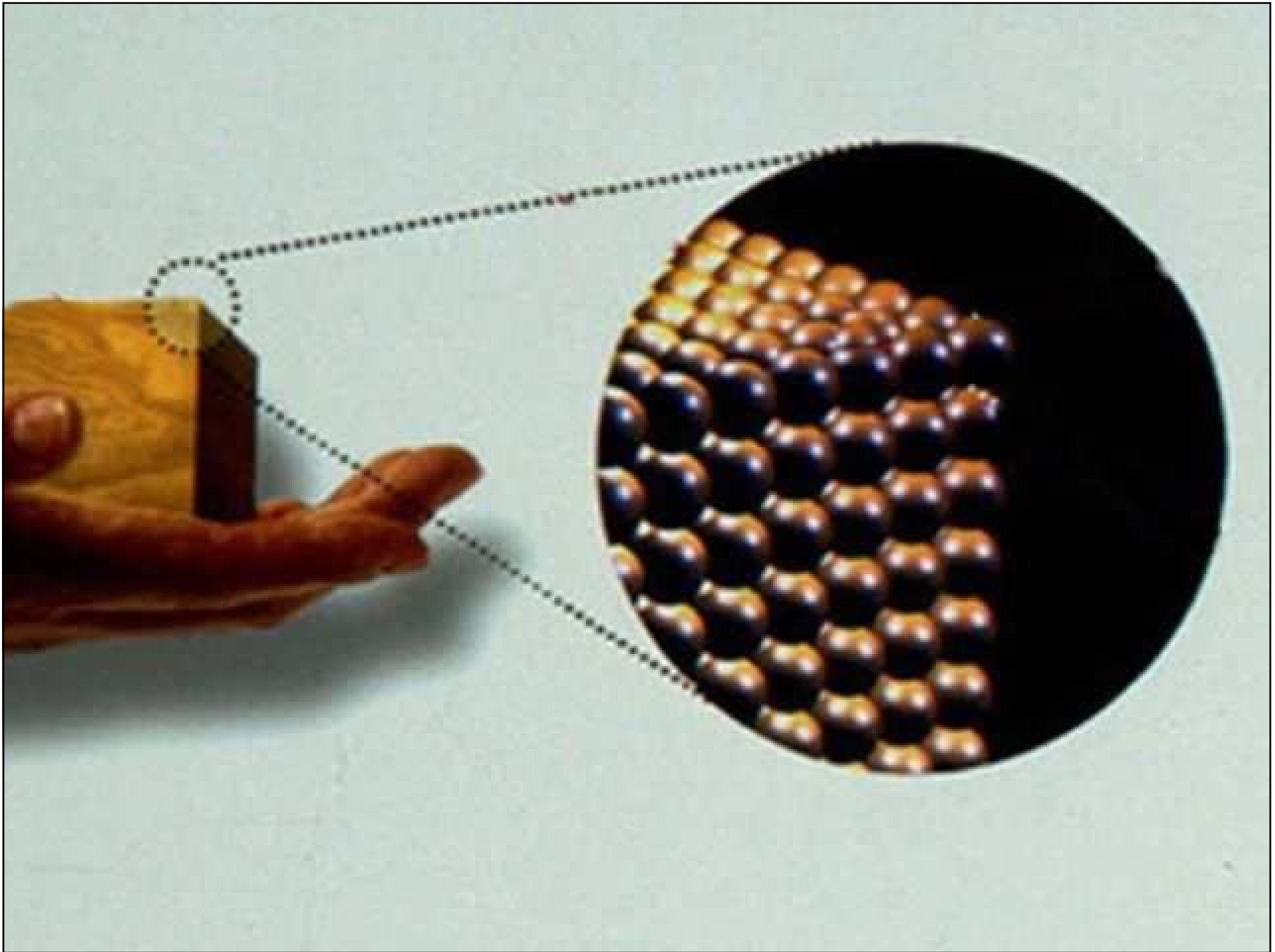

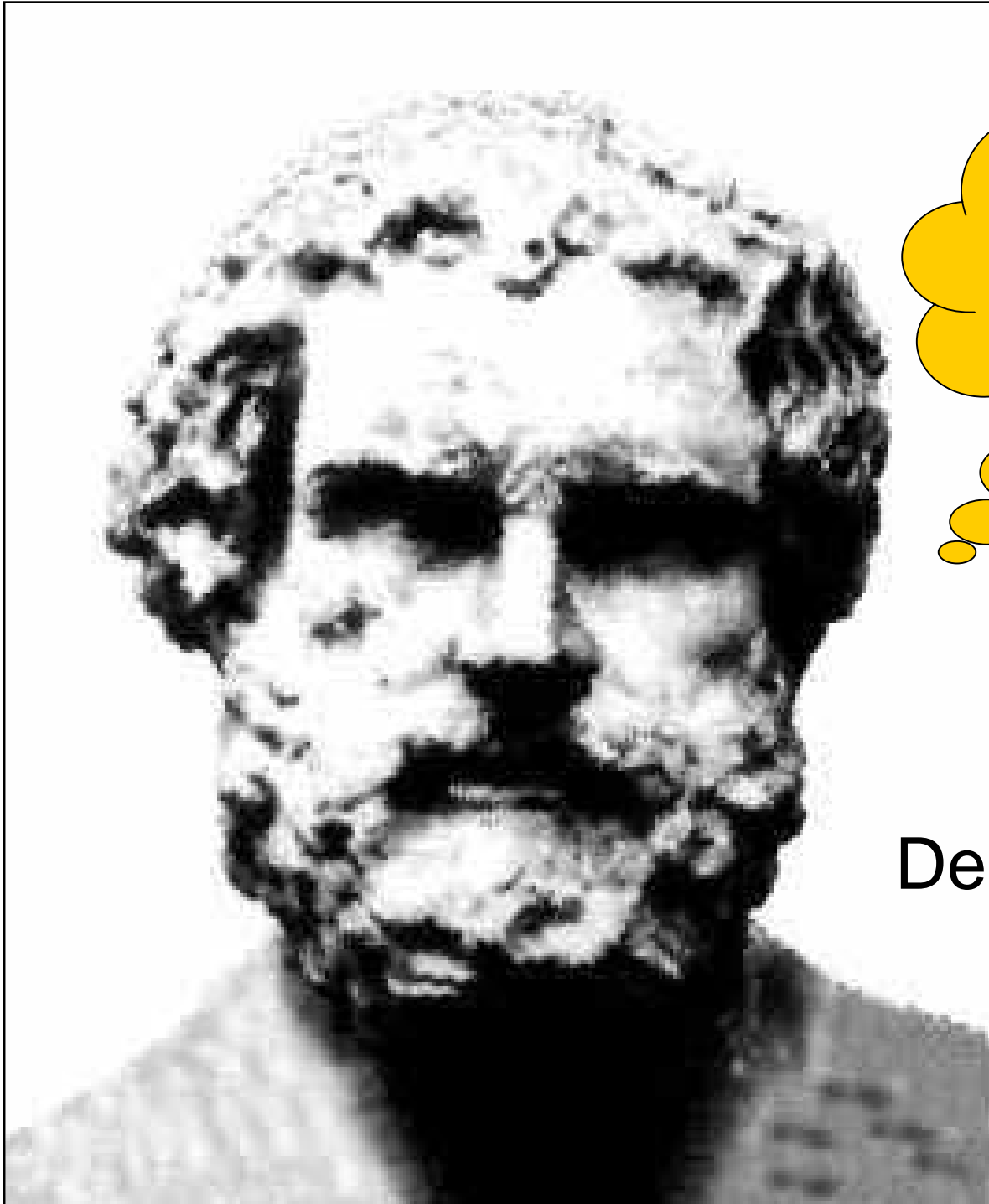

griech.
„atomos“ =
unteilbar

Demokrit, 400 v. Chr.

Braun'sche Röhre

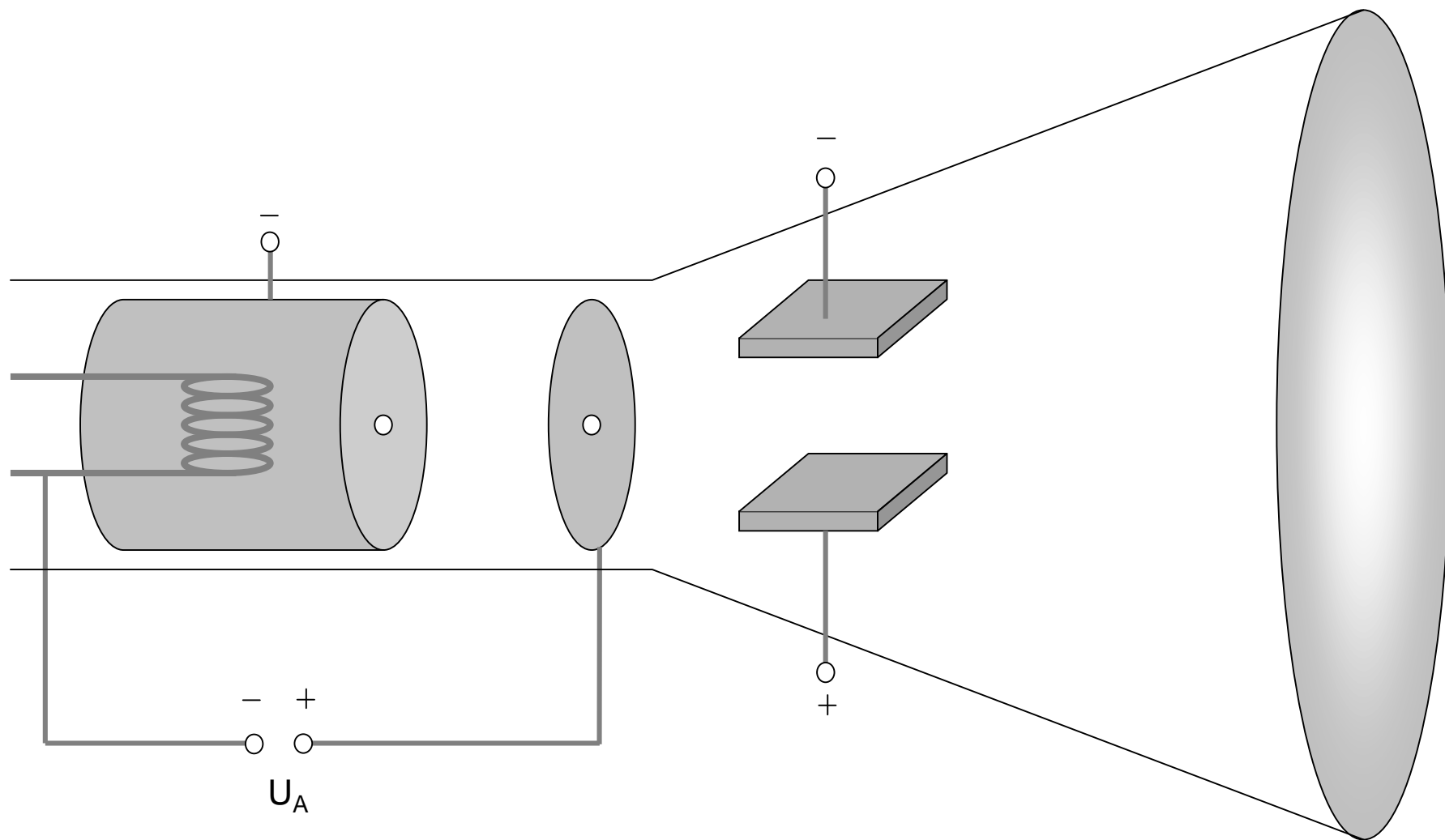

Braun'sche Röhre

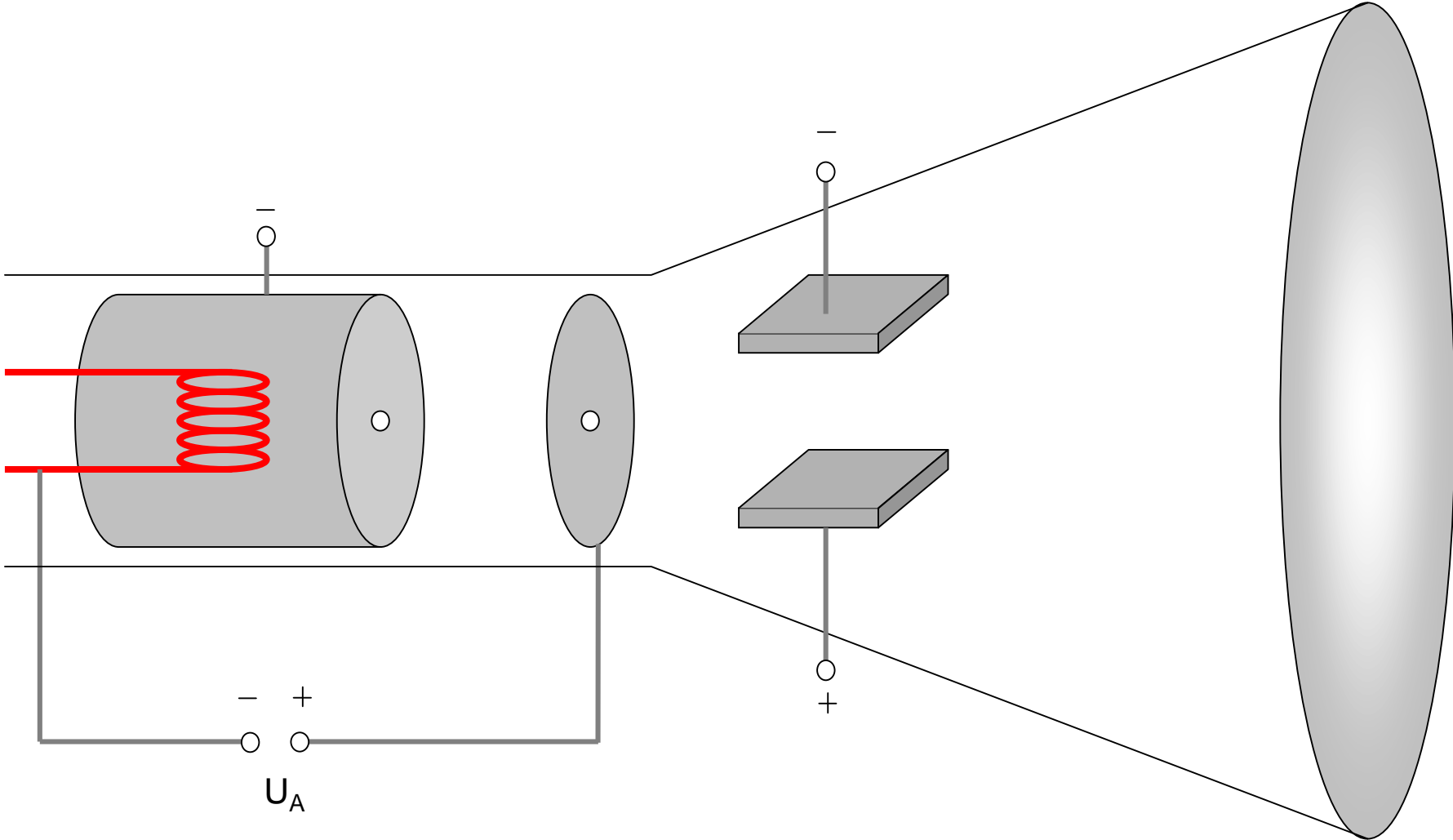

Braun'sche Röhre

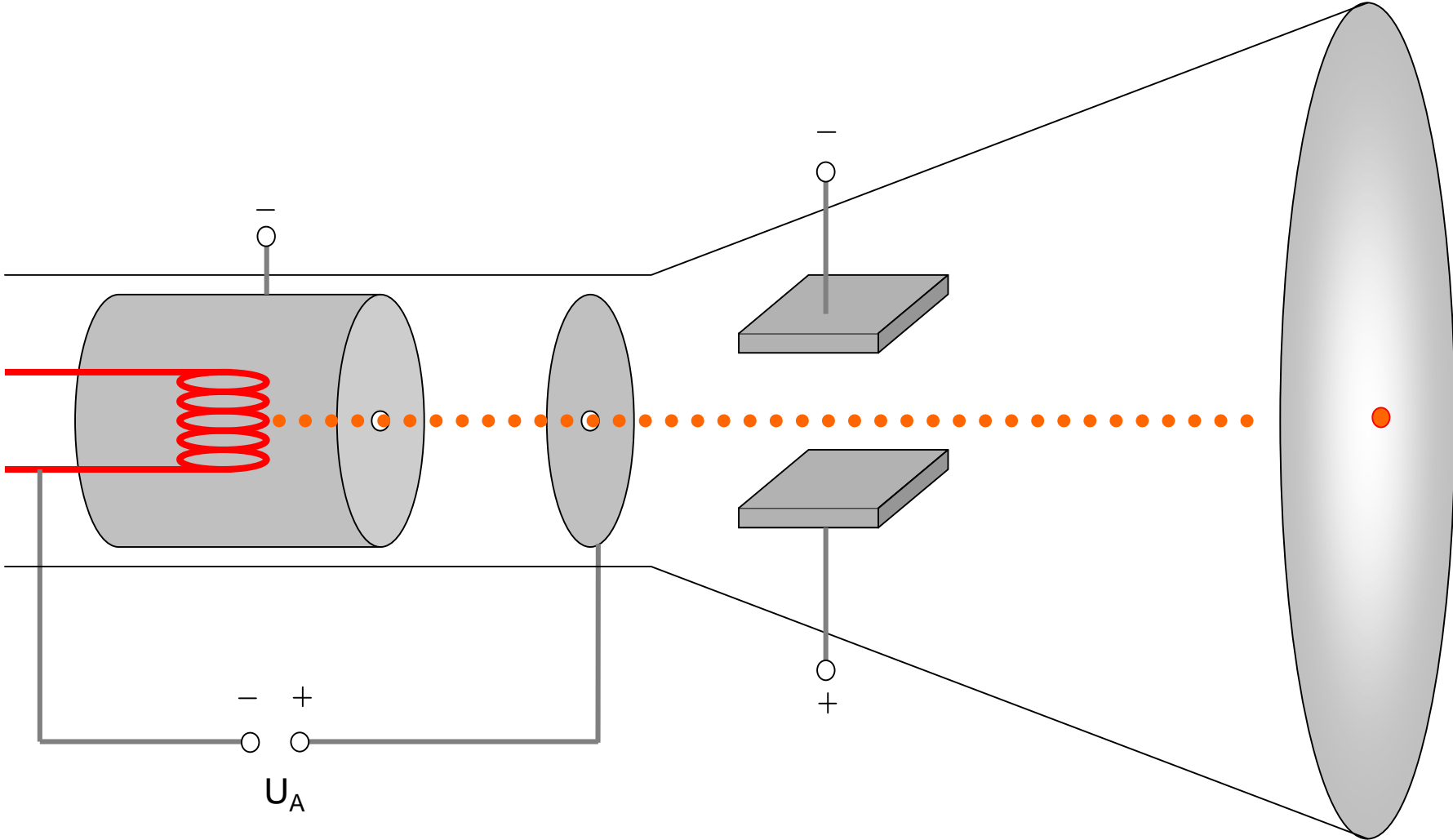

Braun'sche Röhre

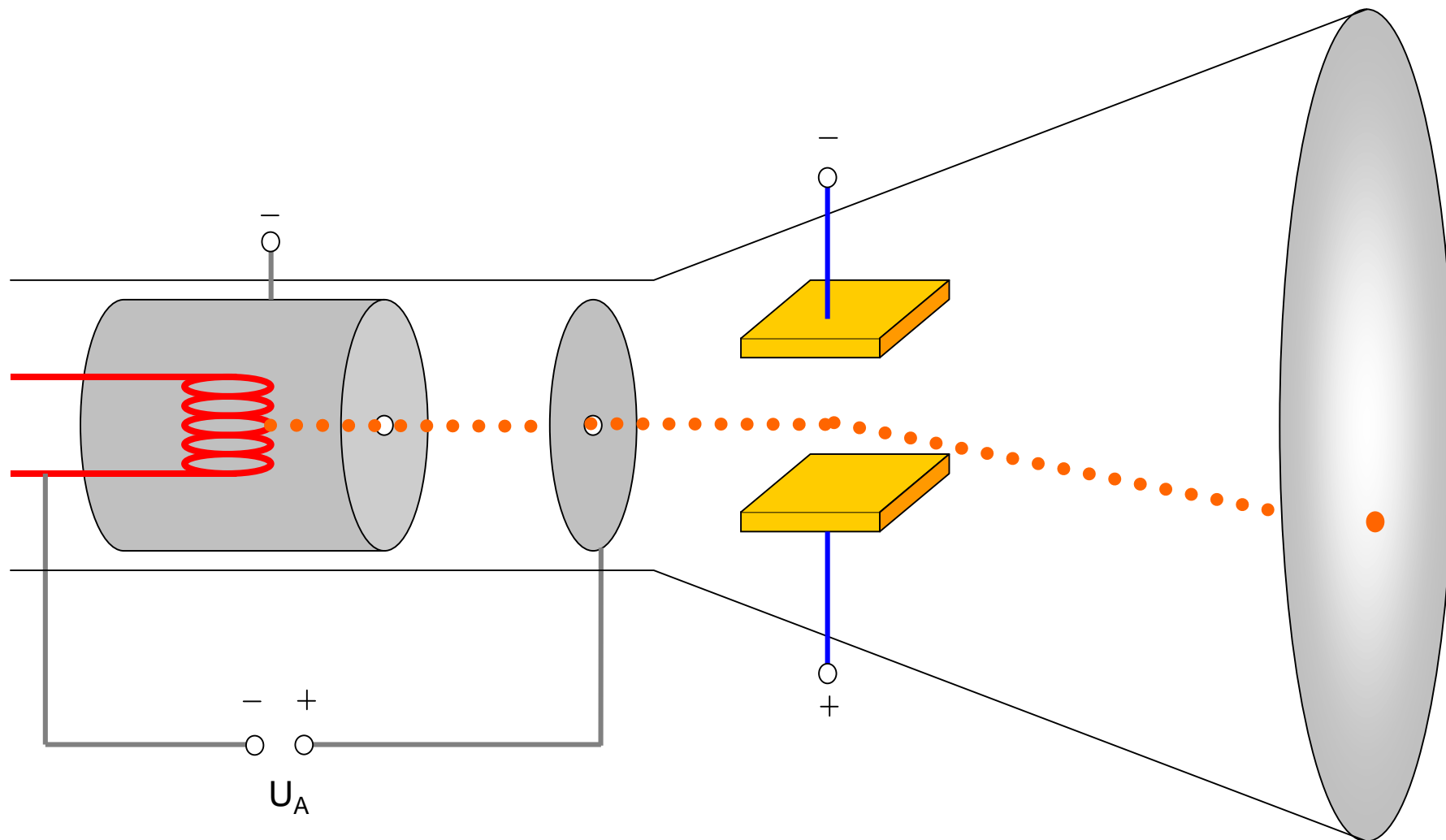

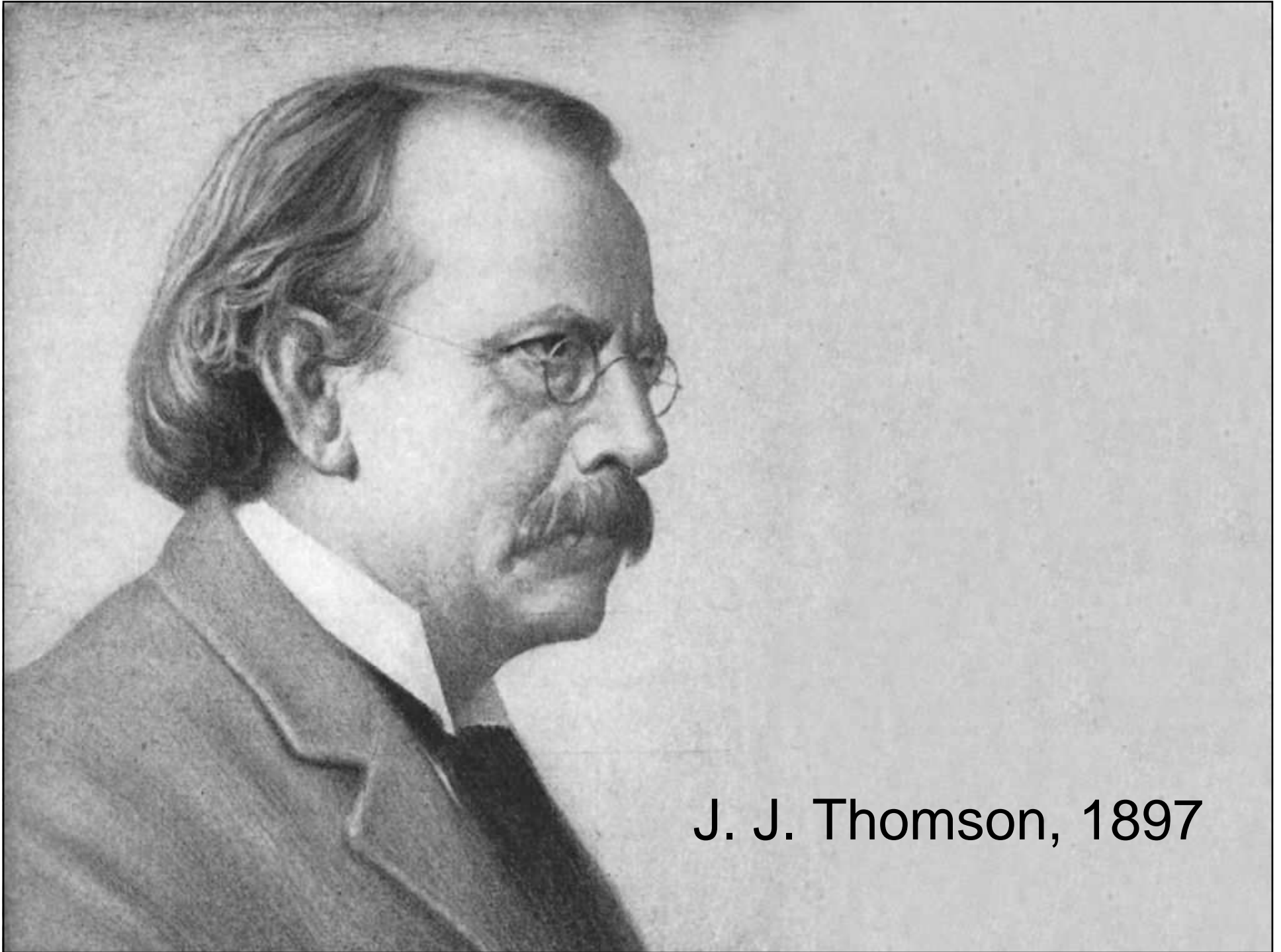

J. J. Thomson, 1897

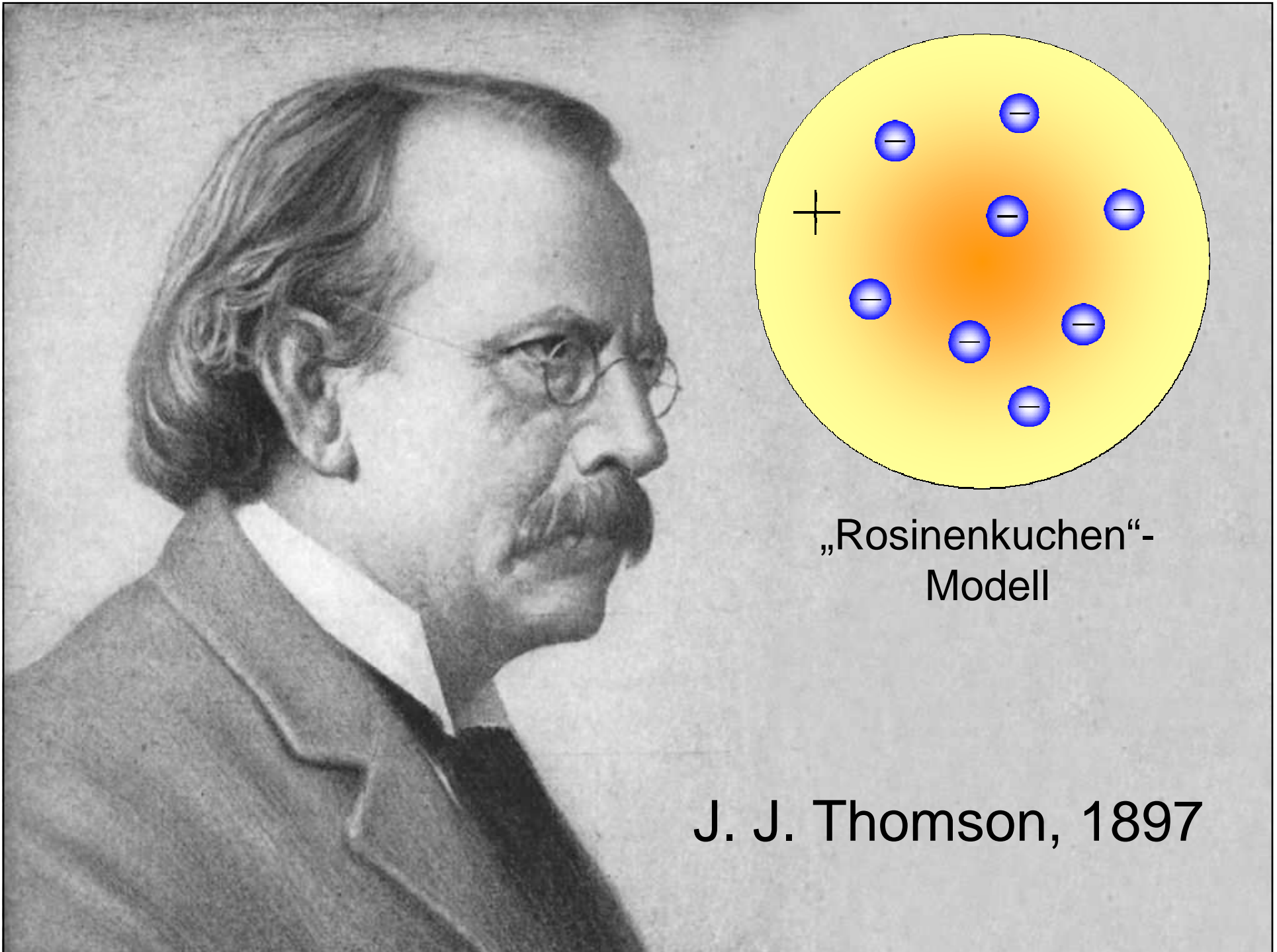

„Rosinenkuchen“-
Modell

J. J. Thomson, 1897

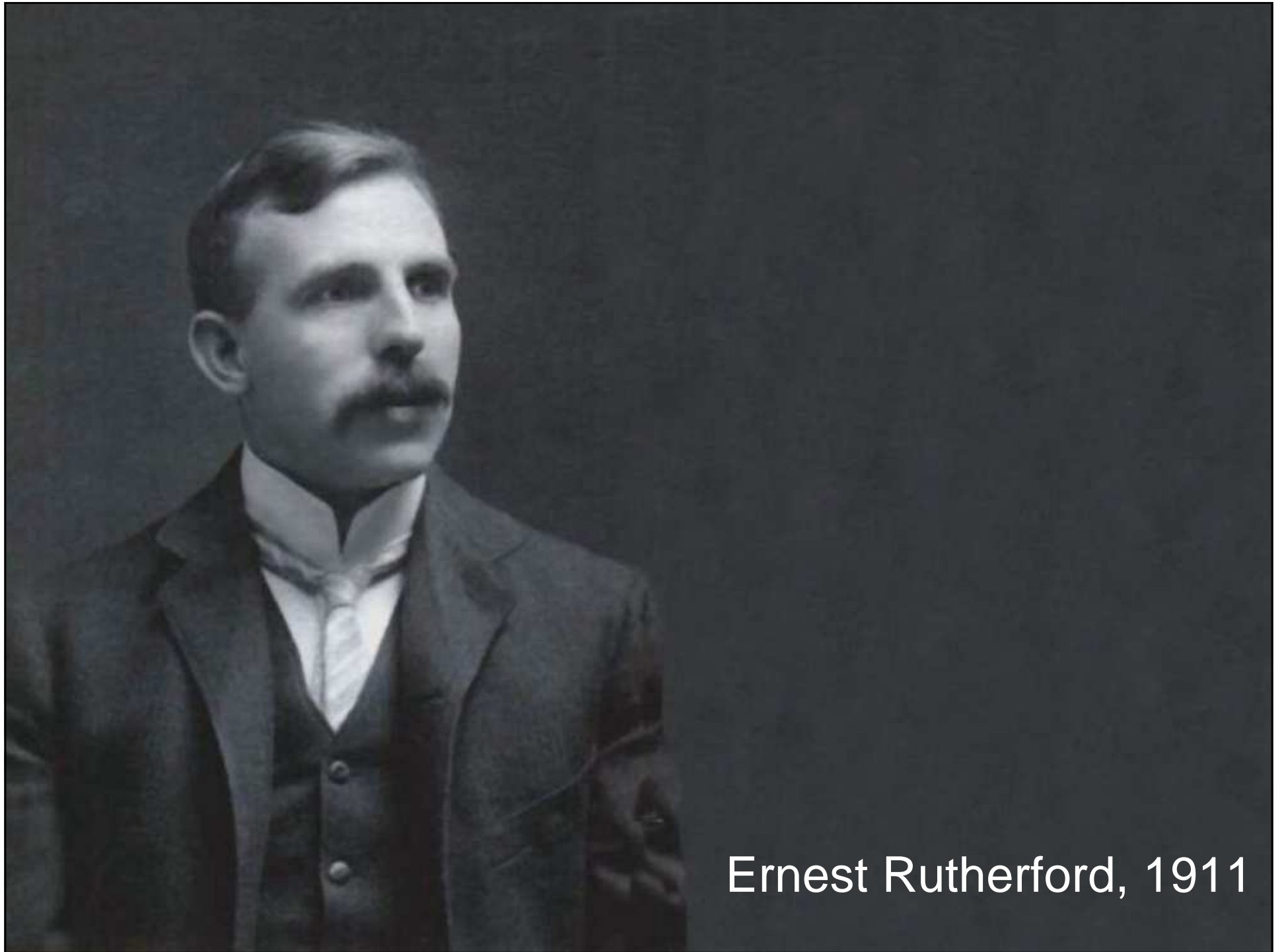

Ernest Rutherford, 1911

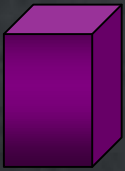
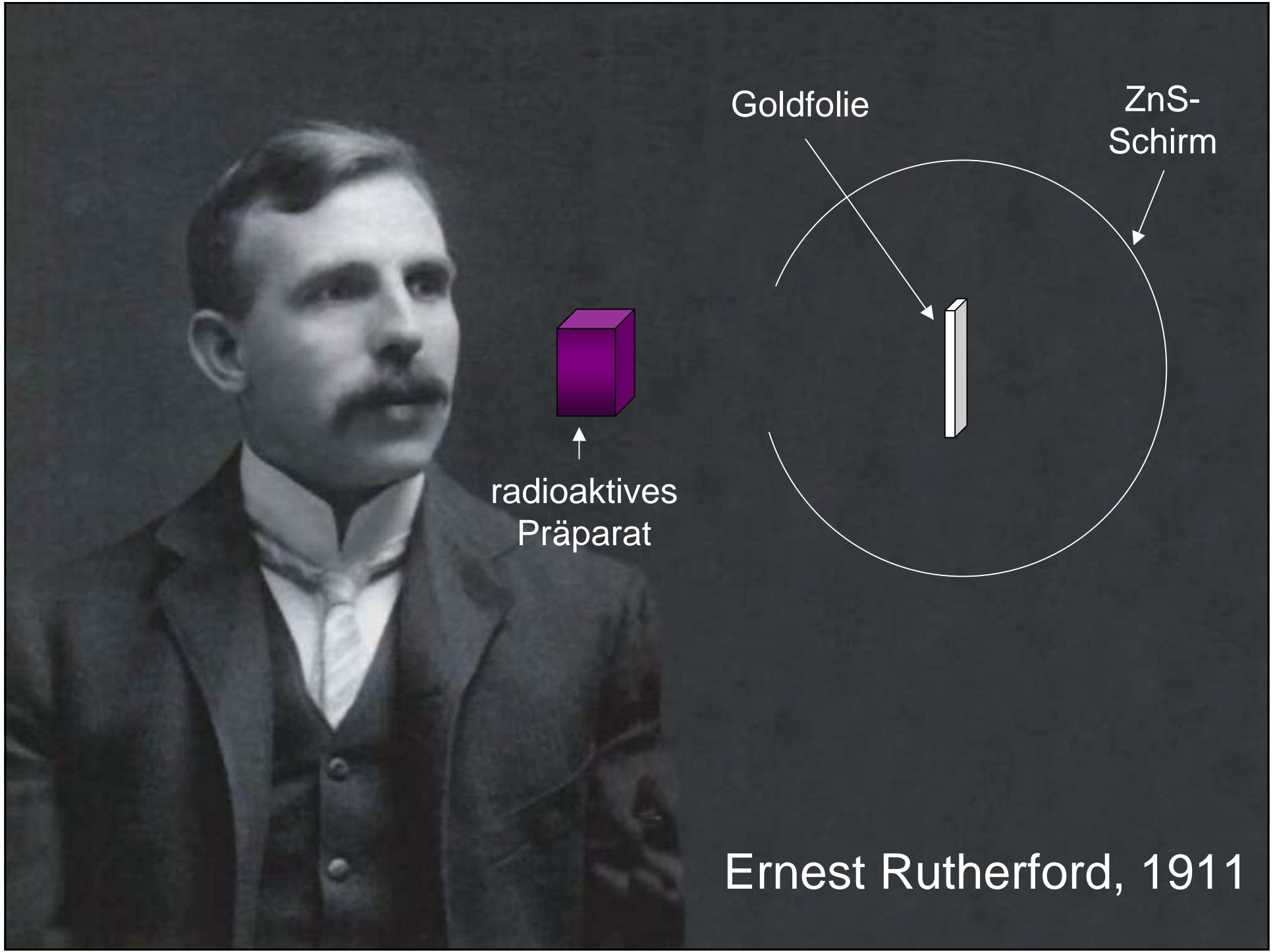

↑
radioaktives
Präparat

Goldfolie

ZnS-
Schirm

Ernest Rutherford, 1911

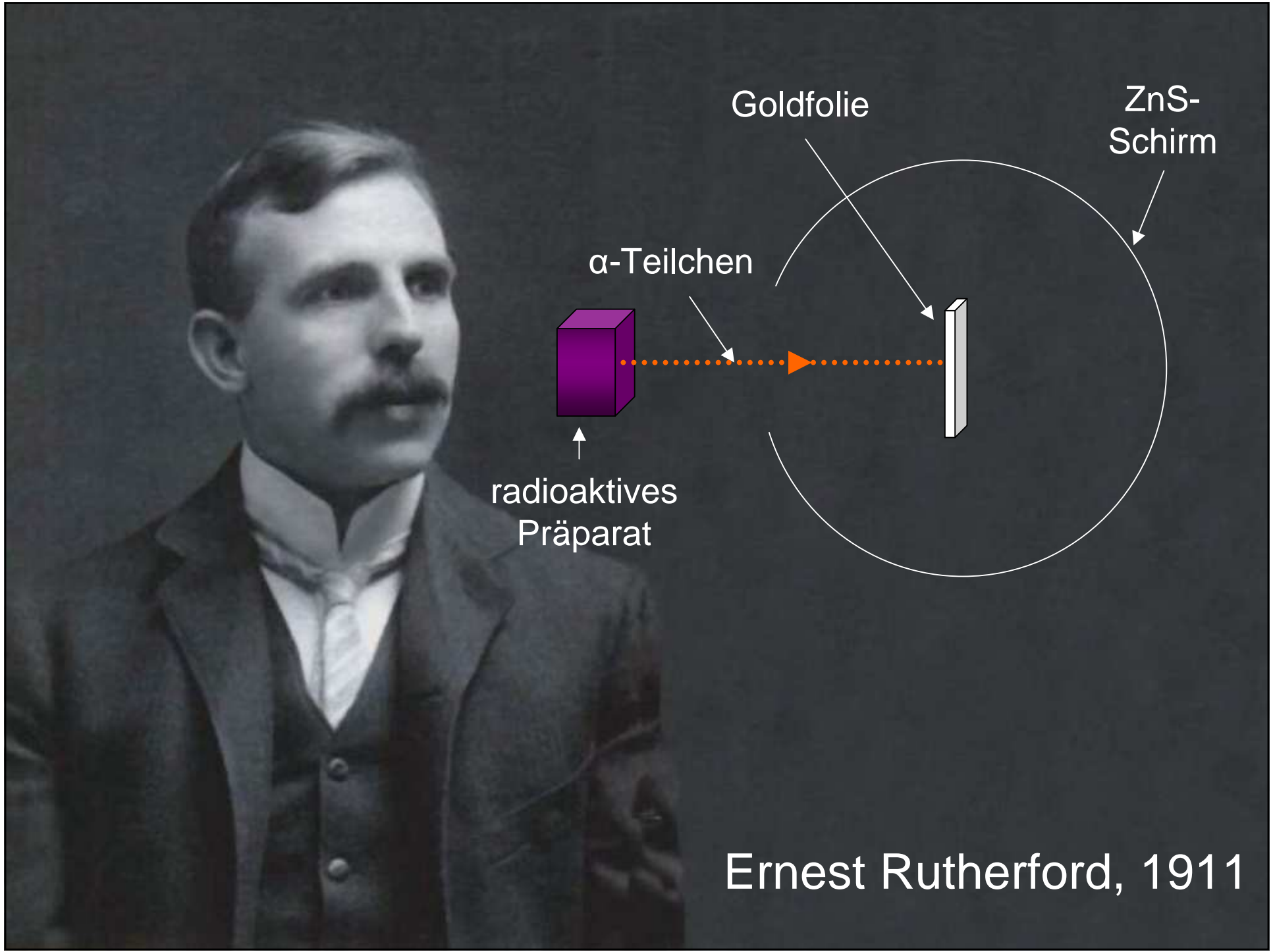

Goldfolie

ZnS-Schirm

α -Teilchen

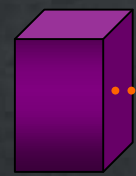

radioaktives
Präparat

Ernest Rutherford, 1911

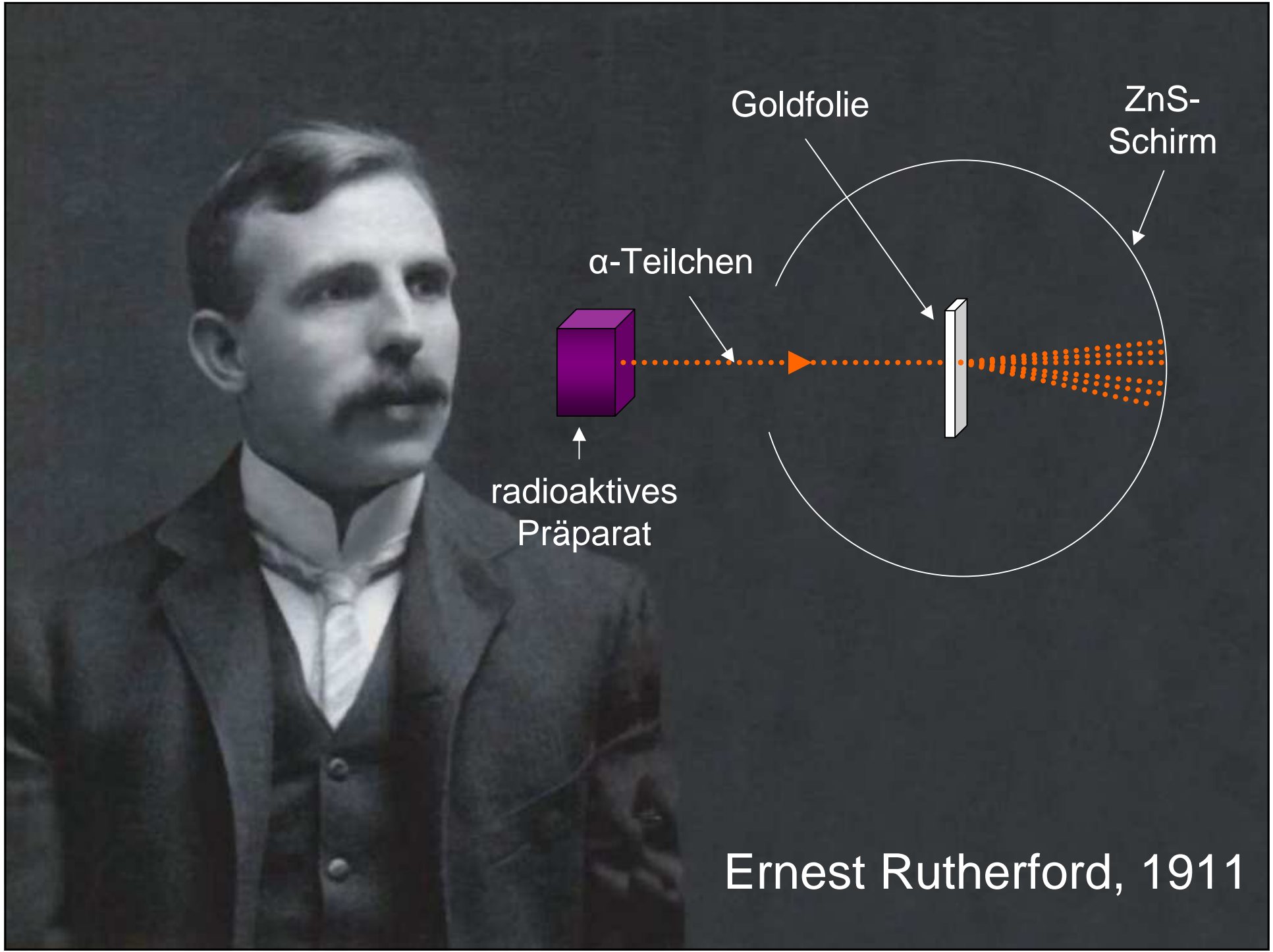

Ernest Rutherford, 1911

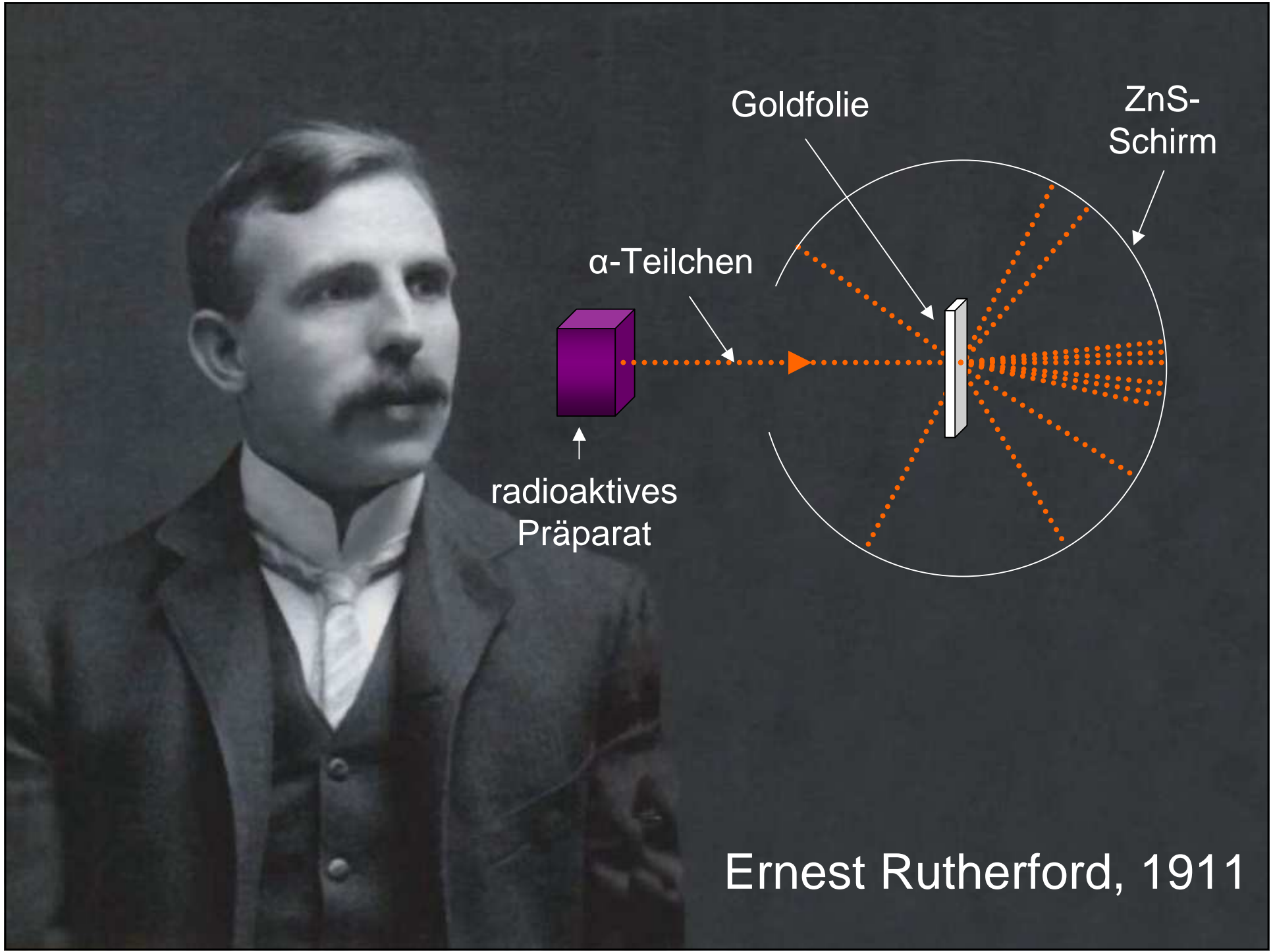

Goldfolie

ZnS-Schirm

α -Teilchen

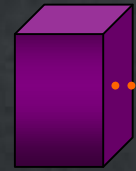

radioaktives
Präparat

Ernest Rutherford, 1911

Rutherford-Modell

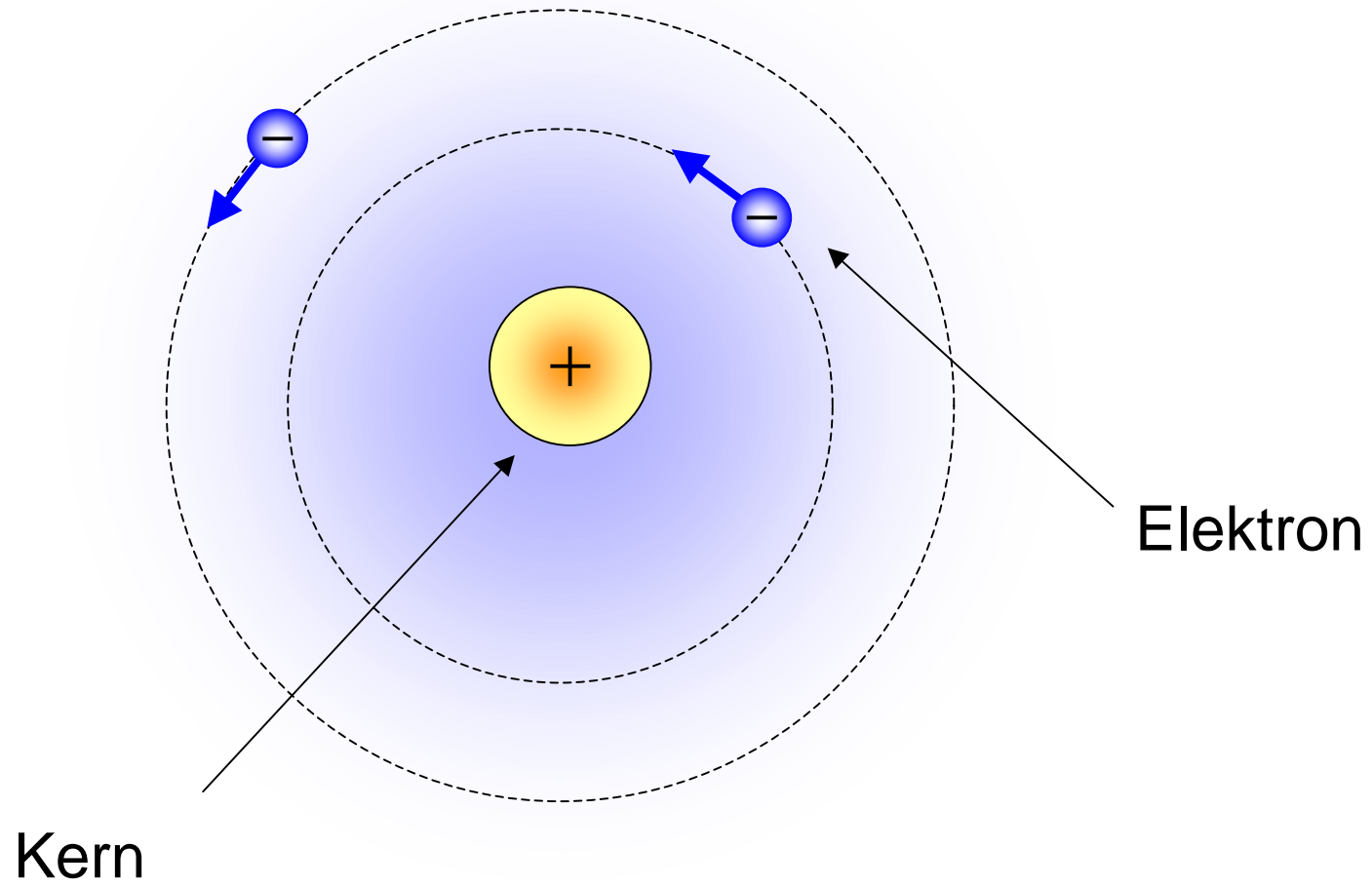

Rutherford-Modell

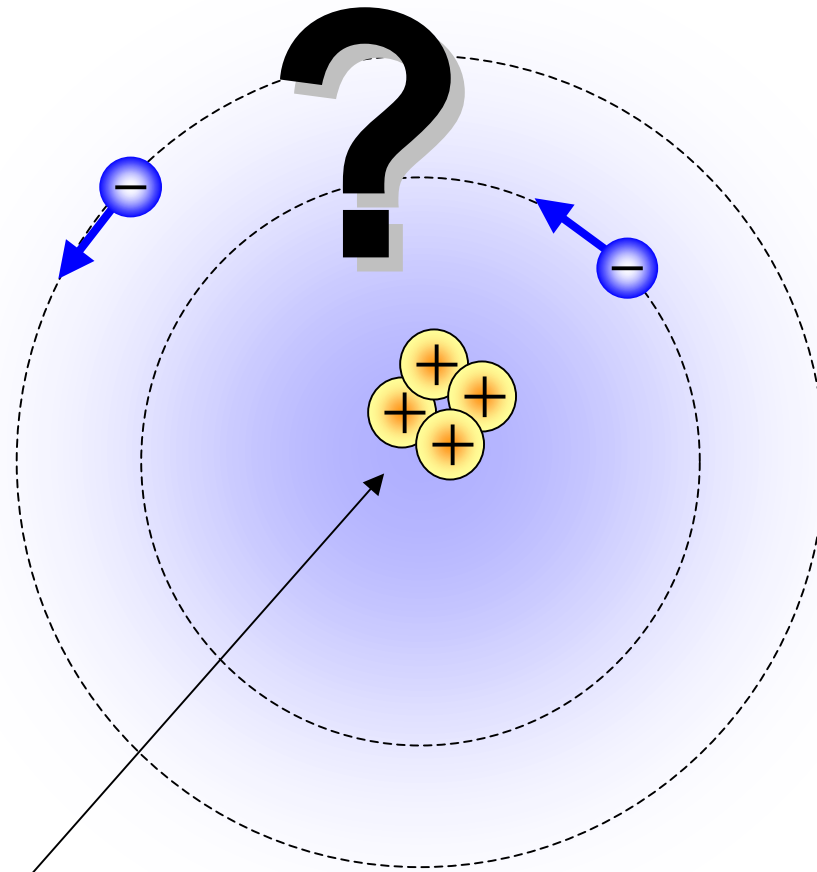

Protonen

Helium-4

Rutherford-Modell

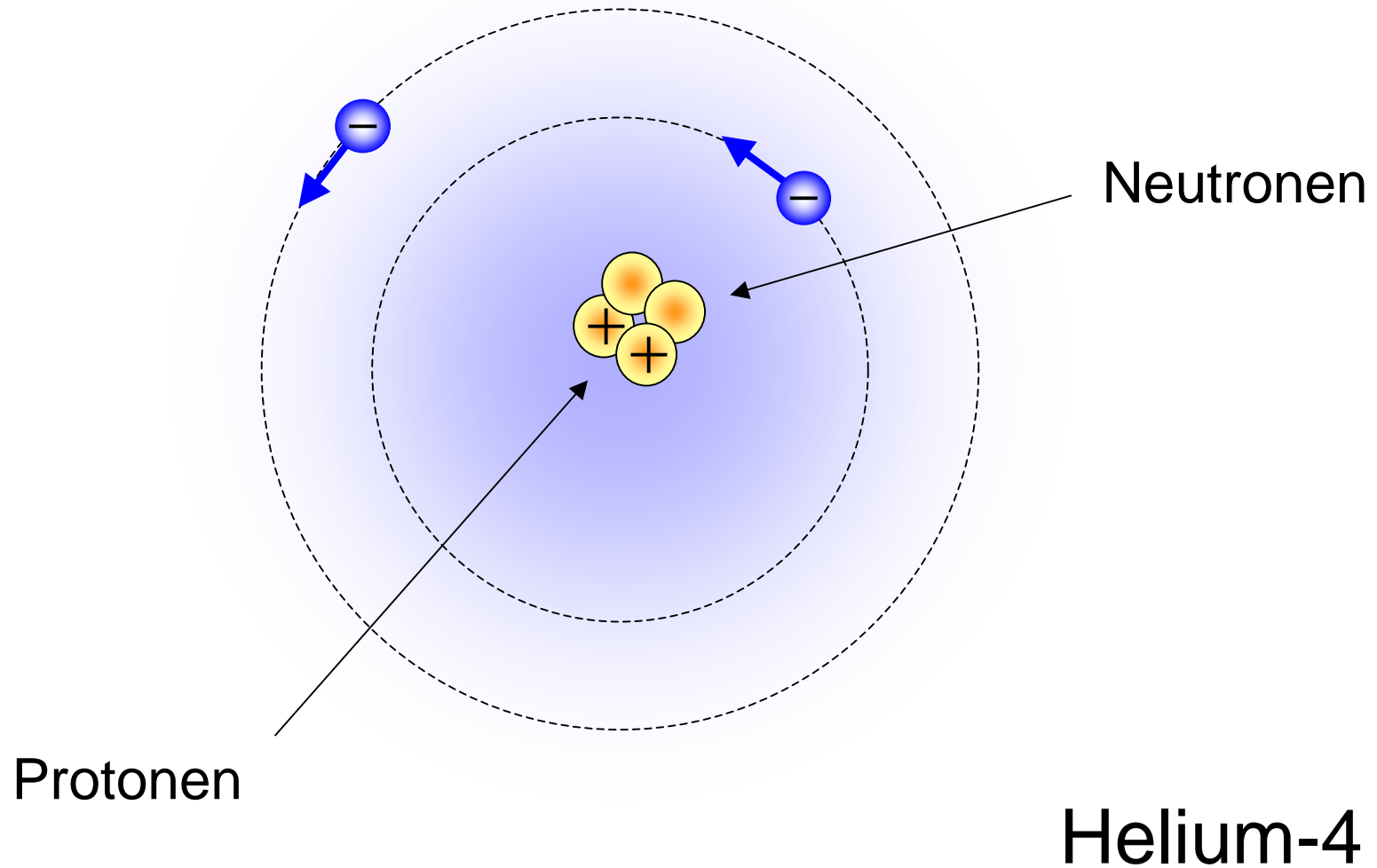

Helium-4

James Chadwick, 1932

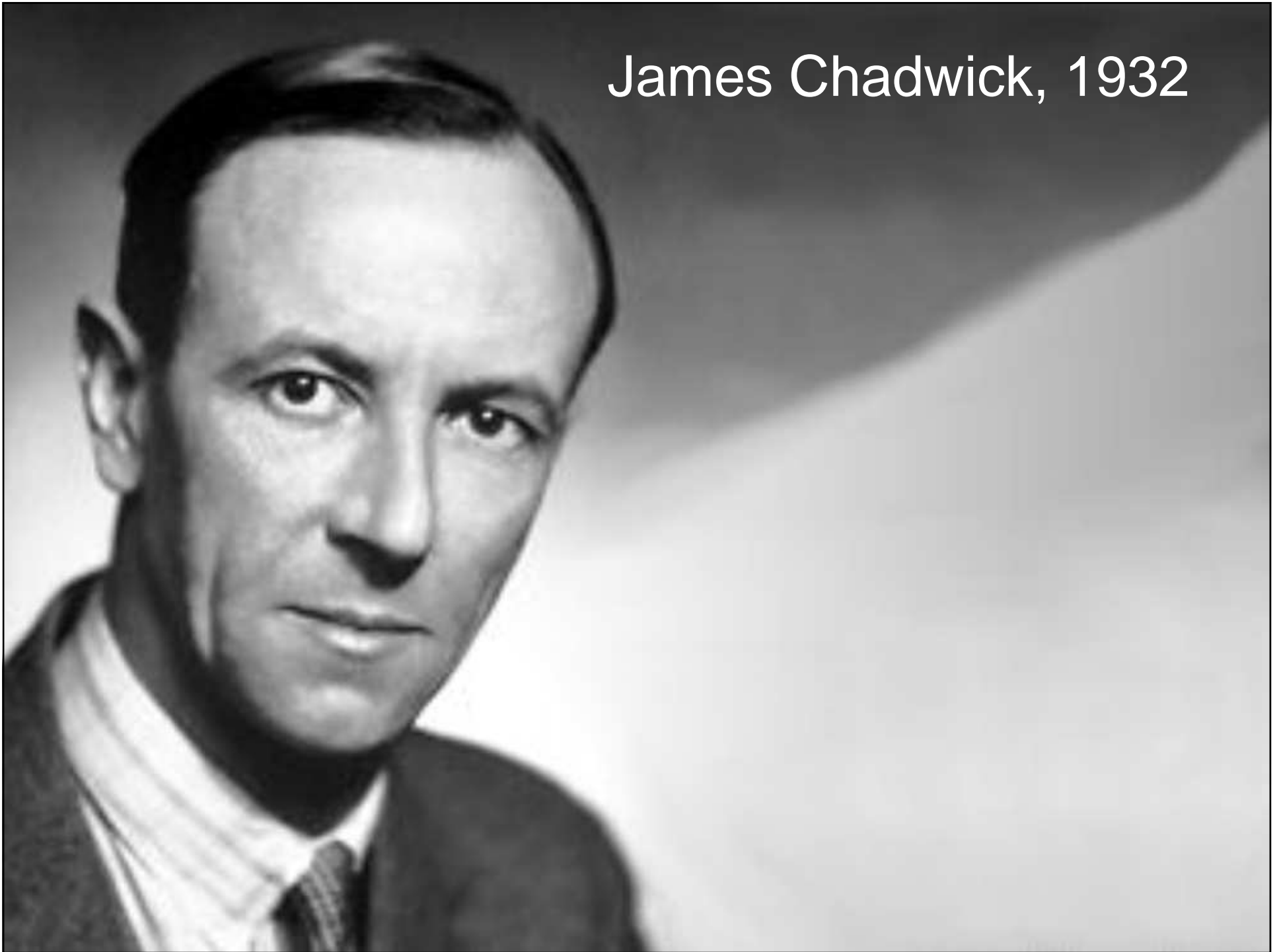

James Chadwick, 1932

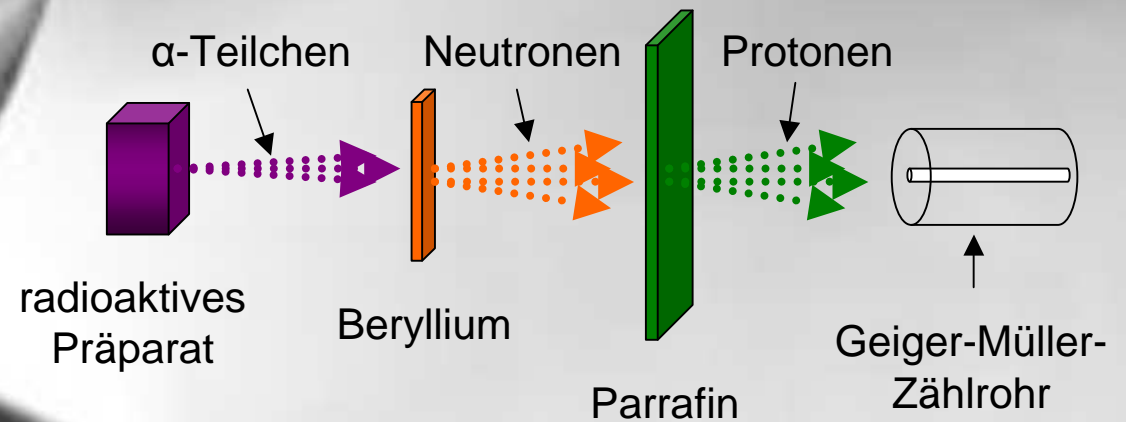

Standardmodell 1932

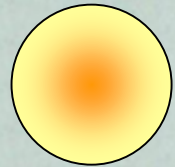

Neutron

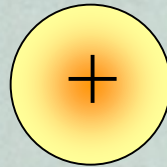

Proton



Elektron

